

# Terapia del Dolor en Distonía

---



Dr. Helard Miranda Aguilar

Neurólogo

Enfermedades del Movimiento

[hmiranda@inca.org.pe](mailto:hmiranda@inca.org.pe)

# Distonia

---

“Contracción involuntaria, variable, sostenida de músculos esqueléticos agonista y antagonistas”

---

# Deformidades de columna

---

- ❑ Postura simiana
- ❑ Camptocormia



# Camptocormia

---



# Camptocormia

---



# Contracturas dolorosas

## Mano estriatal

---

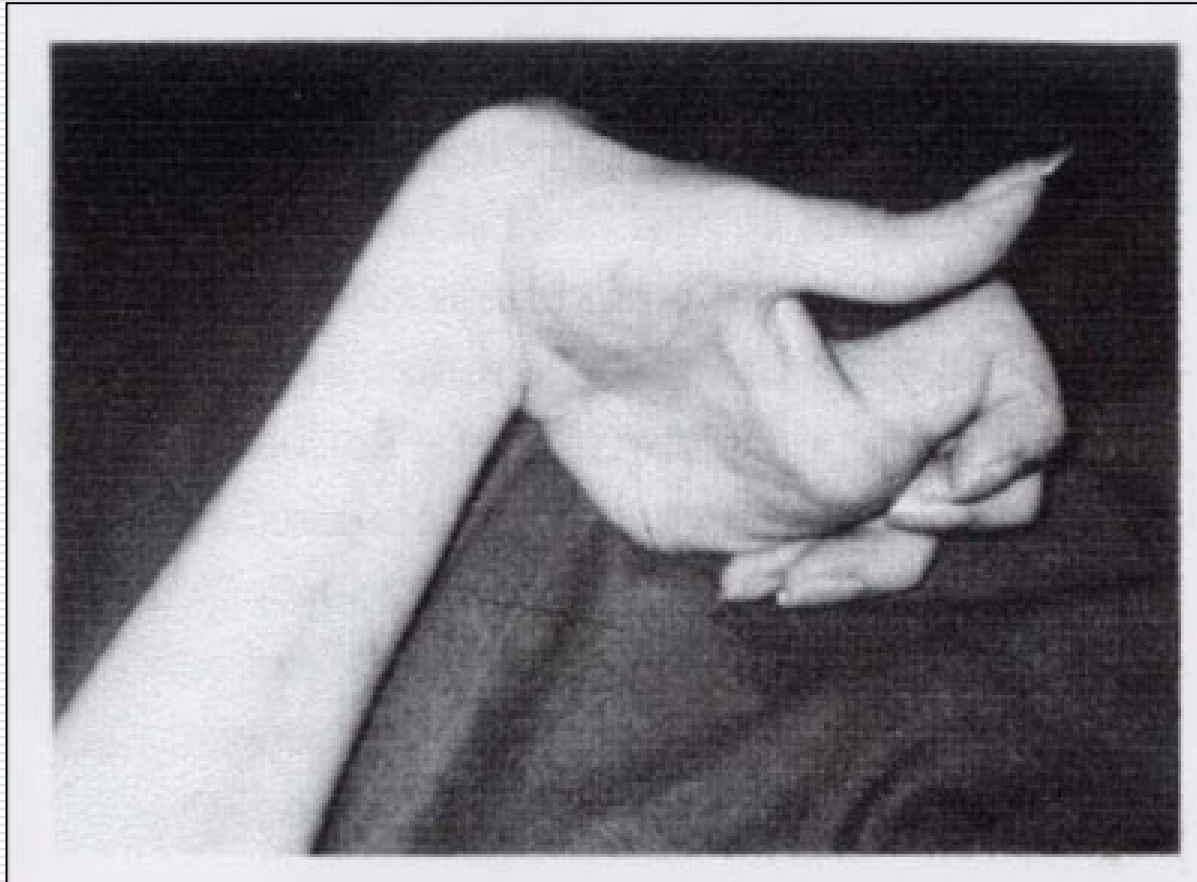

# Contracturas dolorosas

## Pie estriatal

---



# Toxina botulinica

## Mecanismo de accion

---

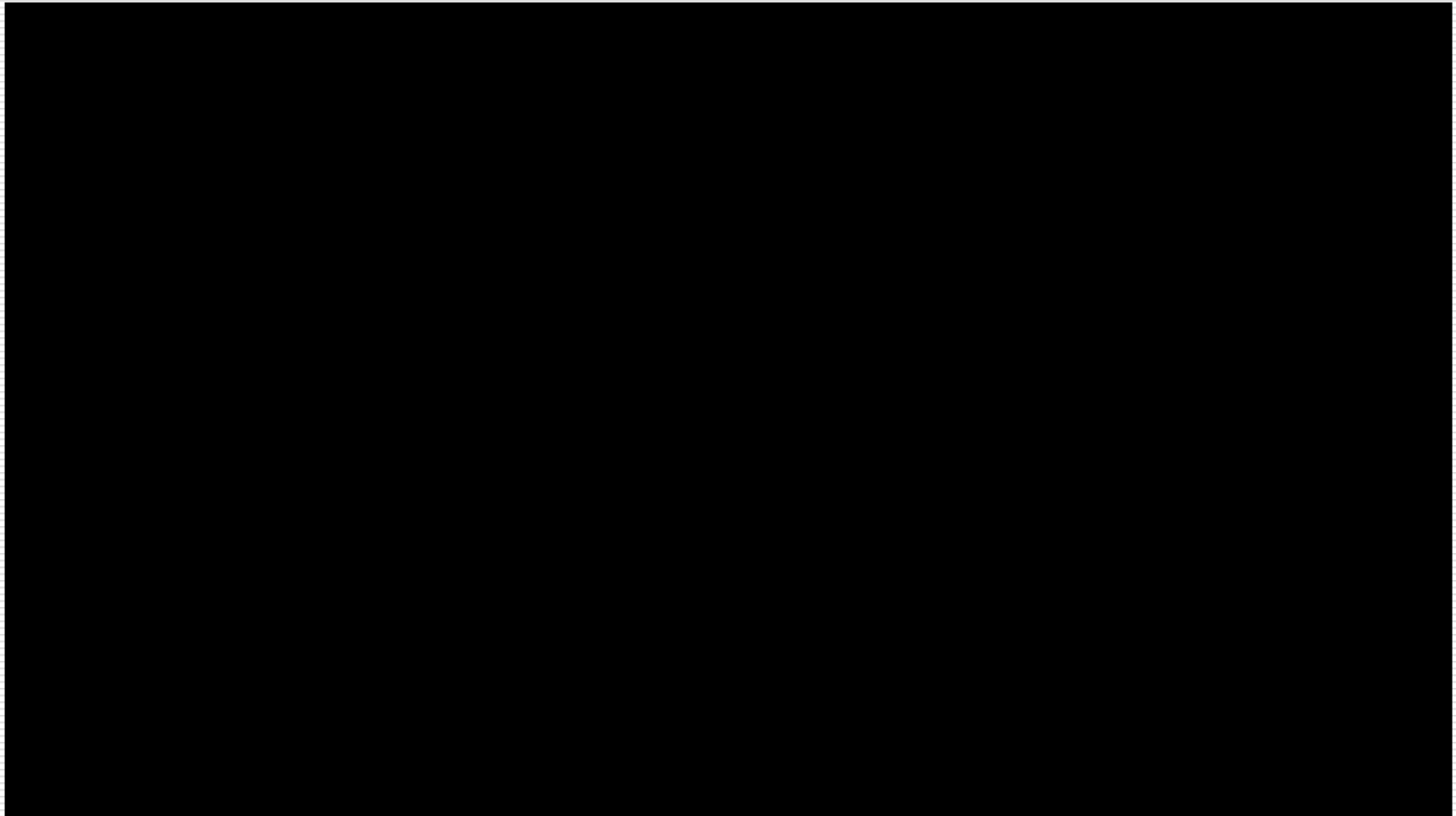

# Lumbalgia no radiculopatica

---

# Toxina botulinica en Lumbalgia no radiculopatica

---

- Disminucion de dolor al paralizar parcialmente musculo en continua tension
    - ↓ de tono muscular
    - ↑ Perfusion muscular
    - ↓ Consumo de O<sub>2</sub>
  - Efecto sobre sistema nervioso autonomo
  - ↓ Cascada provocadora de dolor
-

# Toxina botulinica en Lumbalgia no radiculopatica

## Estudios

---

- Foster et al.
  - 31 pacientes
  - Aleatorizado, doble ciego
  - > 6 meses de dolor lumbar
  - No radiculopatía en EMG e imagen
  - No enfermedad inflamatoria
  - 5 inyecciones en musculos paravertebrales lumbosacros
    - 40 UI de Botox por inyeccion
  - Medicion de dolor por VAS
-

# Toxina botulinica en Lumbalgia no radiculopatica

## Estudios

---

- A 3 semanas
    - Botox: 86% alivio de dolor
    - Placebo: 31% alivio de dolor
  - A 8 semanas
    - Botox: 60% alivio de dolor
    - Placebo: 12.5% alivio de dolor
  - A 6 meses
    - Botox: No alivio de dolor
    - Placebo: No alivio de dolor
-

# Tecnica

## Lumbalgia no radiculopatica

---

- Intramuscular
- Aplicaciones sobre  
músculos paravertebrales

# Distonia cervical

---

# Dosis

## Cervico toraxico

---

	Botox (BTx-A)	Myobloc (BTx-B)	Inyecciones por musculo
Puntos gatillo	20-25	No datos	1-4
Dosis total	100-257	5000-9000	

# Tecnica

Cervico toraxico

---

- Intramuscular
- Aplicaciones sobre parrilla costal
  - Riego de neumotorax

# Tecnica

## Cervico toraxico

---

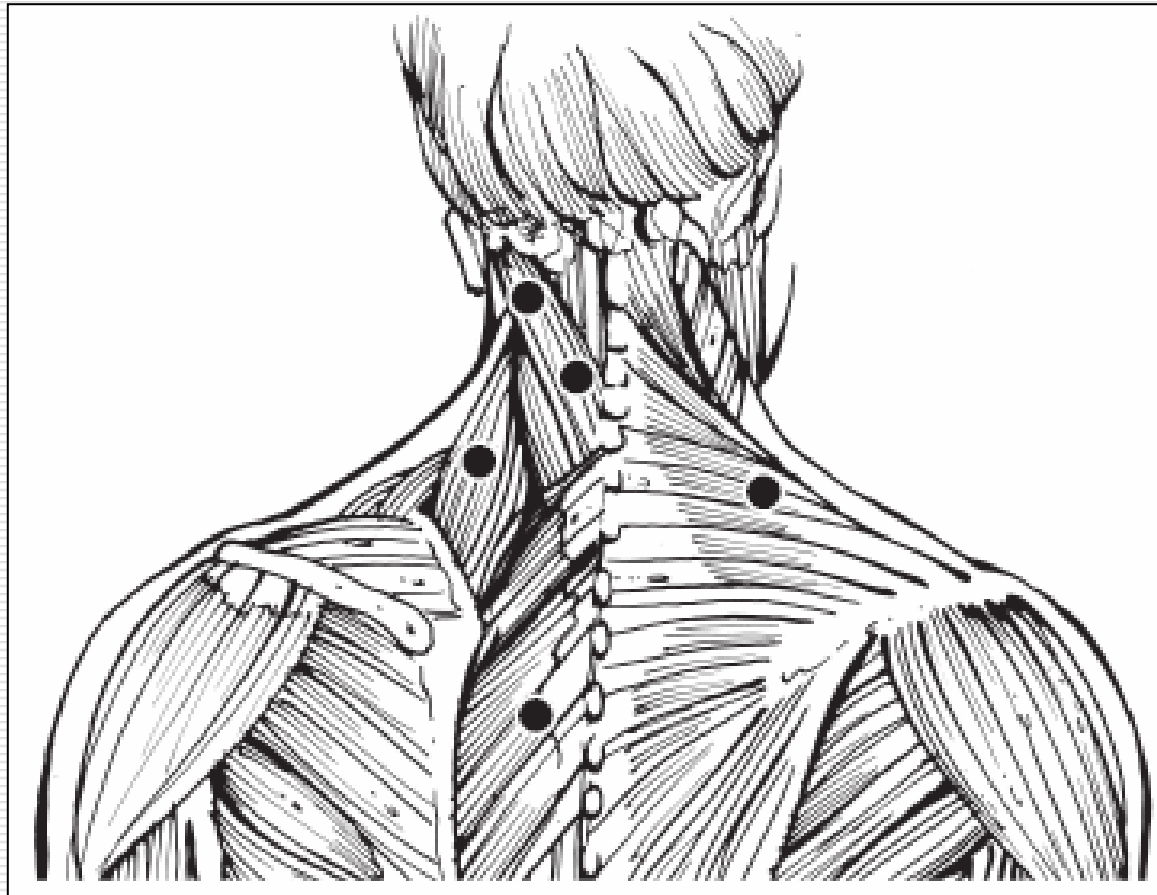

# Dosis

## Lumbosacro

---

	Botox (BTx-A)	Myobloc (BTx-B)	Inyecciones por musculo
Puntos gatillo	40/sitio	1250/sitio	1-4
Dosis total	200	10000	

# Tecnica

Cervico toraxico

---

- Intramuscular
- Inyeccion sobre el musculo cuadrado
  - Con guia EMG y/o radiologica

# Tecnica

## Lumbosacro

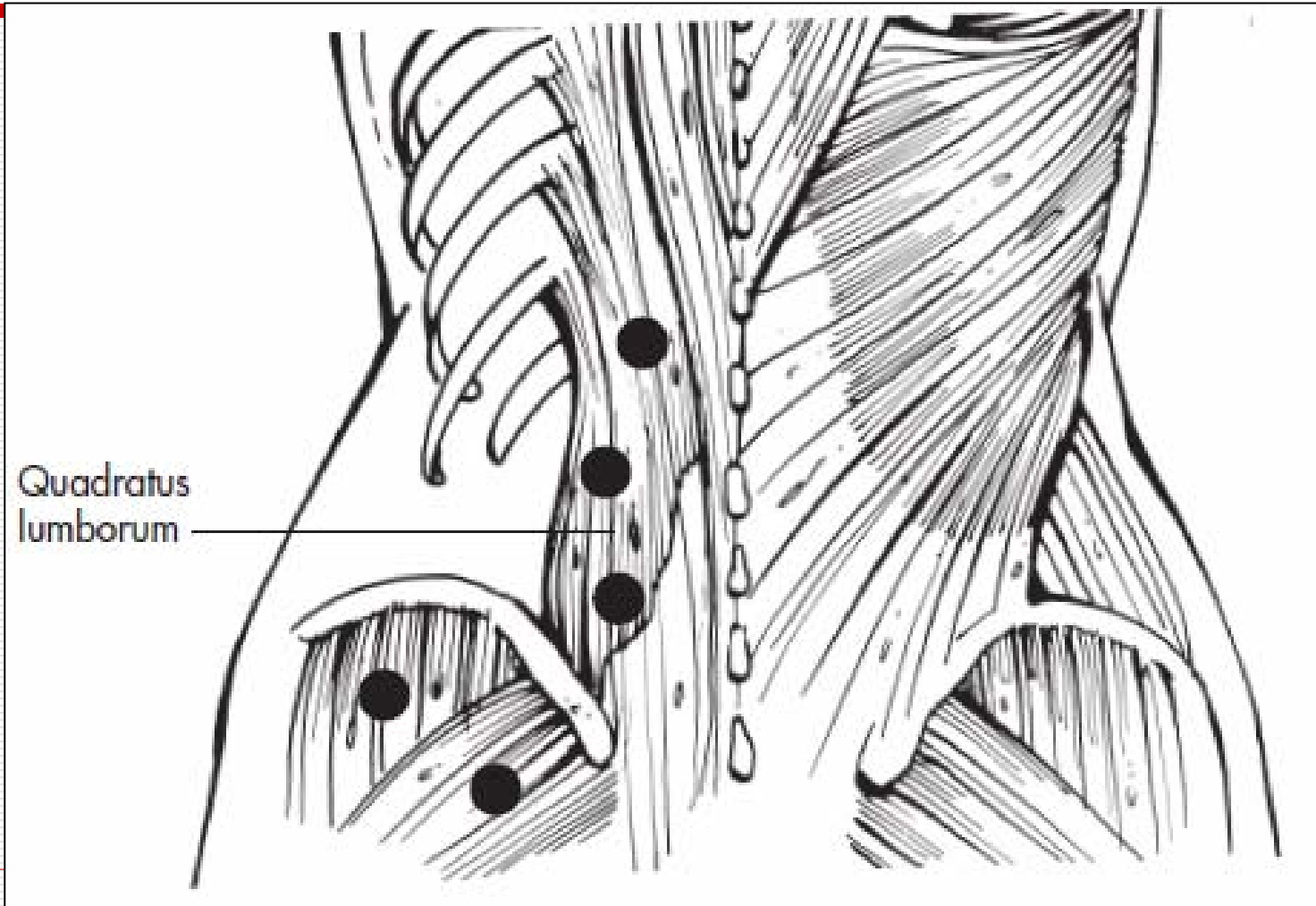

# Sindrome piriforme

---

# Dosis

## Piriforme

---

	Botox (BTx-A)	Myobloc (BTx-B)	Inyecciones por musculo
Musculo piriforme	100-200	2500-5000	1
Dosis total	400	5000	

# Sindrome piriforme

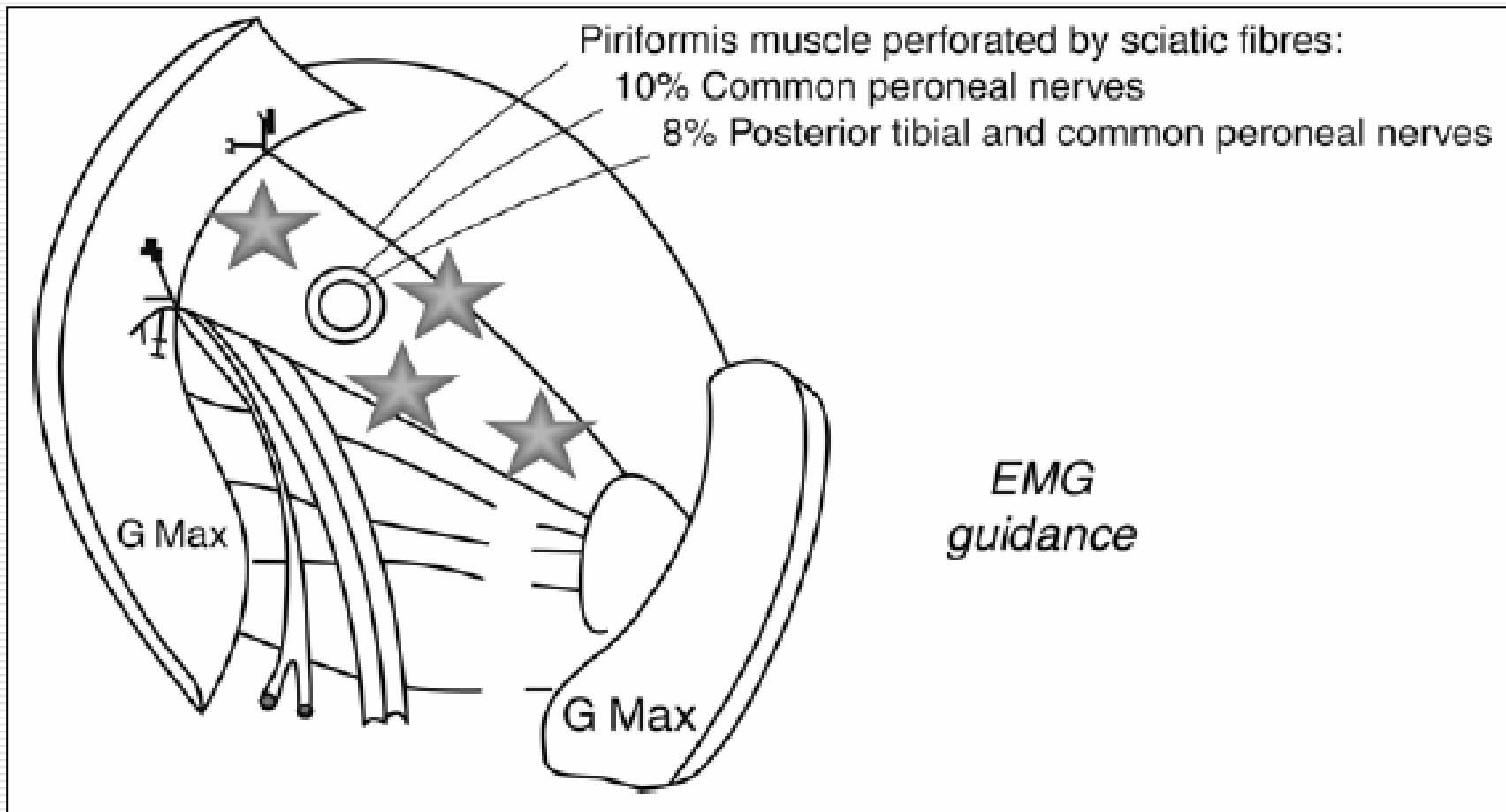

# Tecnica

## Piriforme

---

### Tecnica de Fisher

- Un tercio de la distancia desde
    - Trocarter mayor al punto de maximo dolor
    - Aguja dirigida al ombligo
    - Inyeccion del punto motor
  - Rotacion externa del miembro activara el musculo piriforme
-

# Síndrome piriforme



# Síndrome piriforme

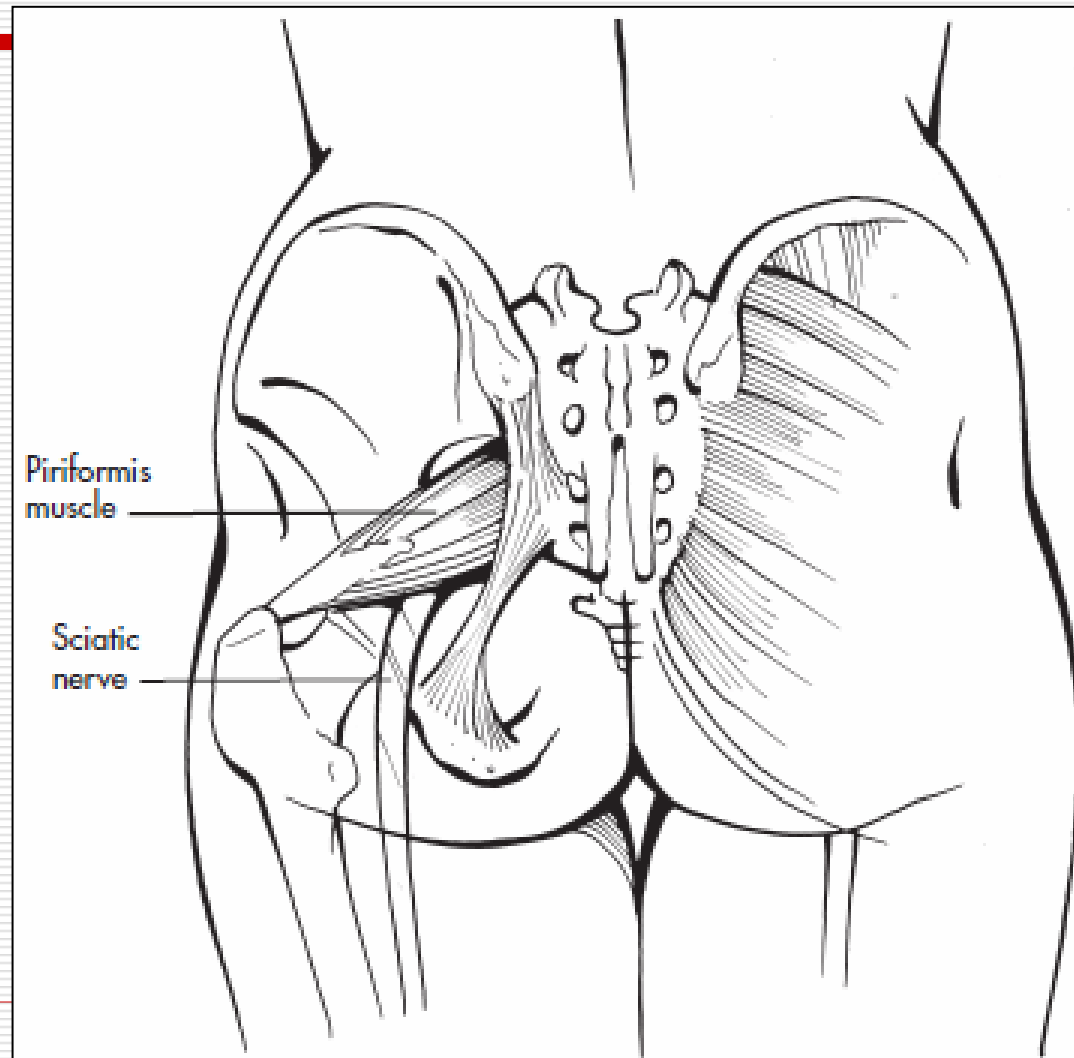

# Estimulacion Cerebral Profunda

---

# DYT1 Distonia



# Nucleos de la base: Dystonia generalizada

---

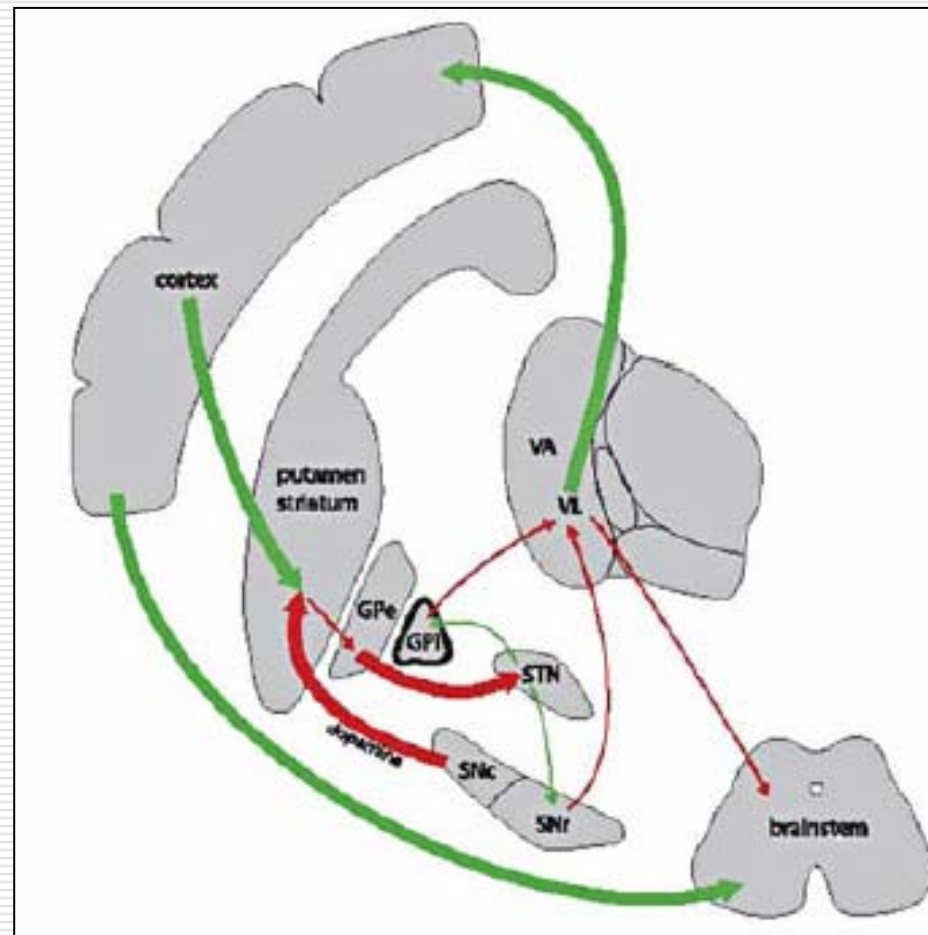

# GPI MER

---

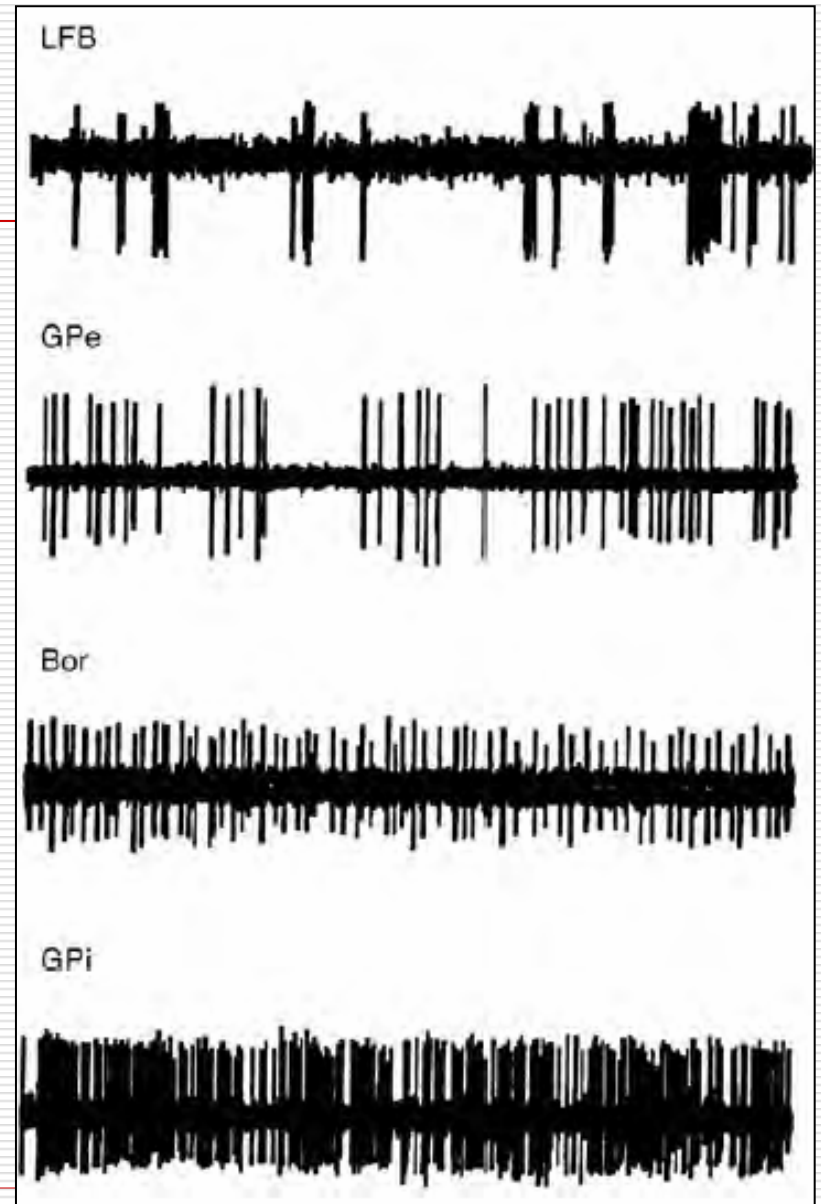
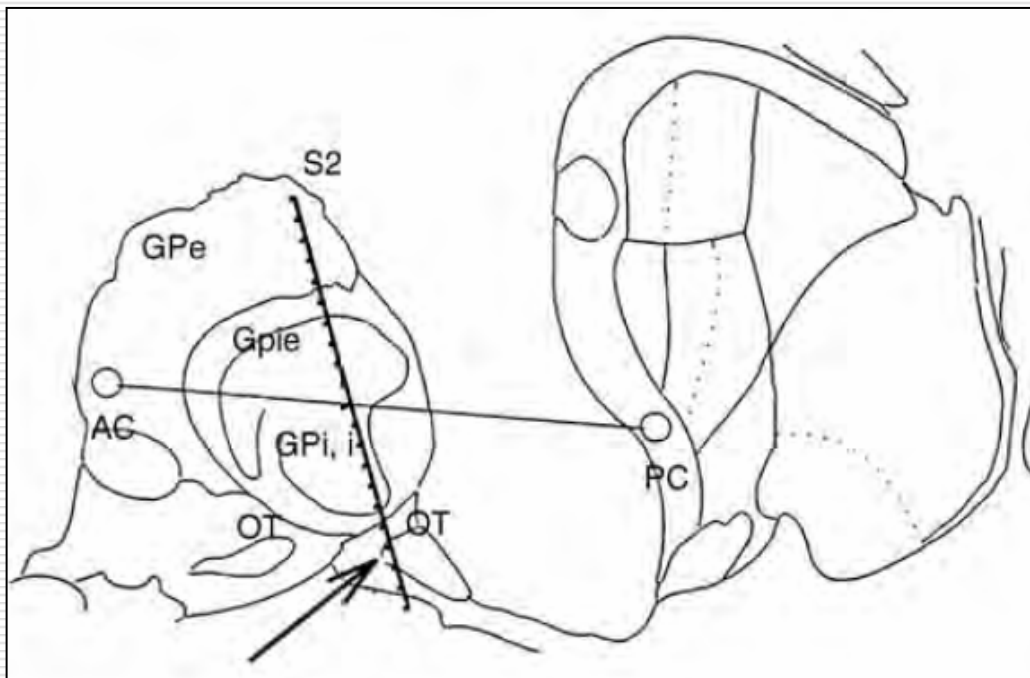

# Linea intercomisural



# Schaltenbrand and Wahren Atlas

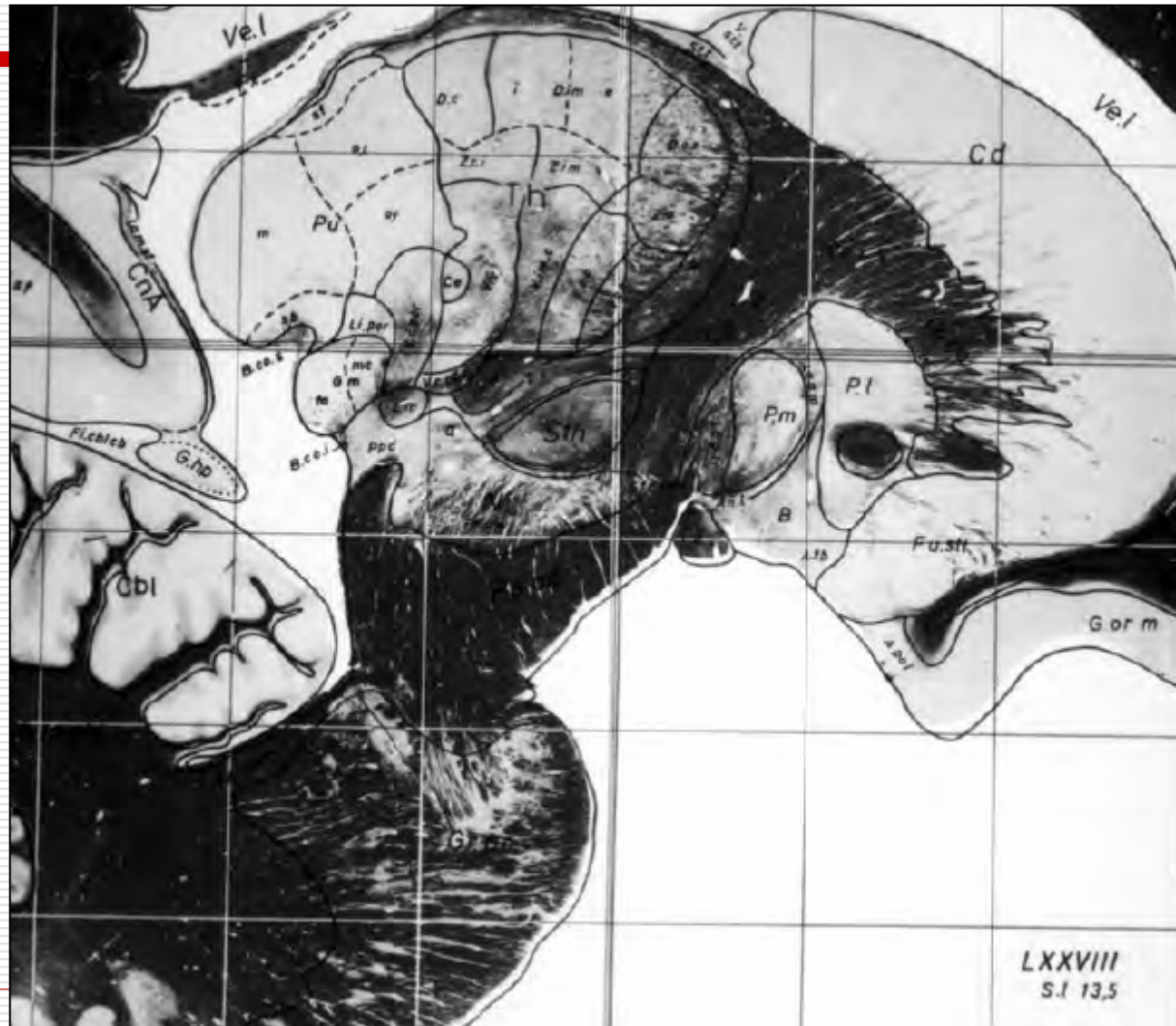

# Original Leksell stereotactic coordinate frame



# Leksell stereotactic coordinate system

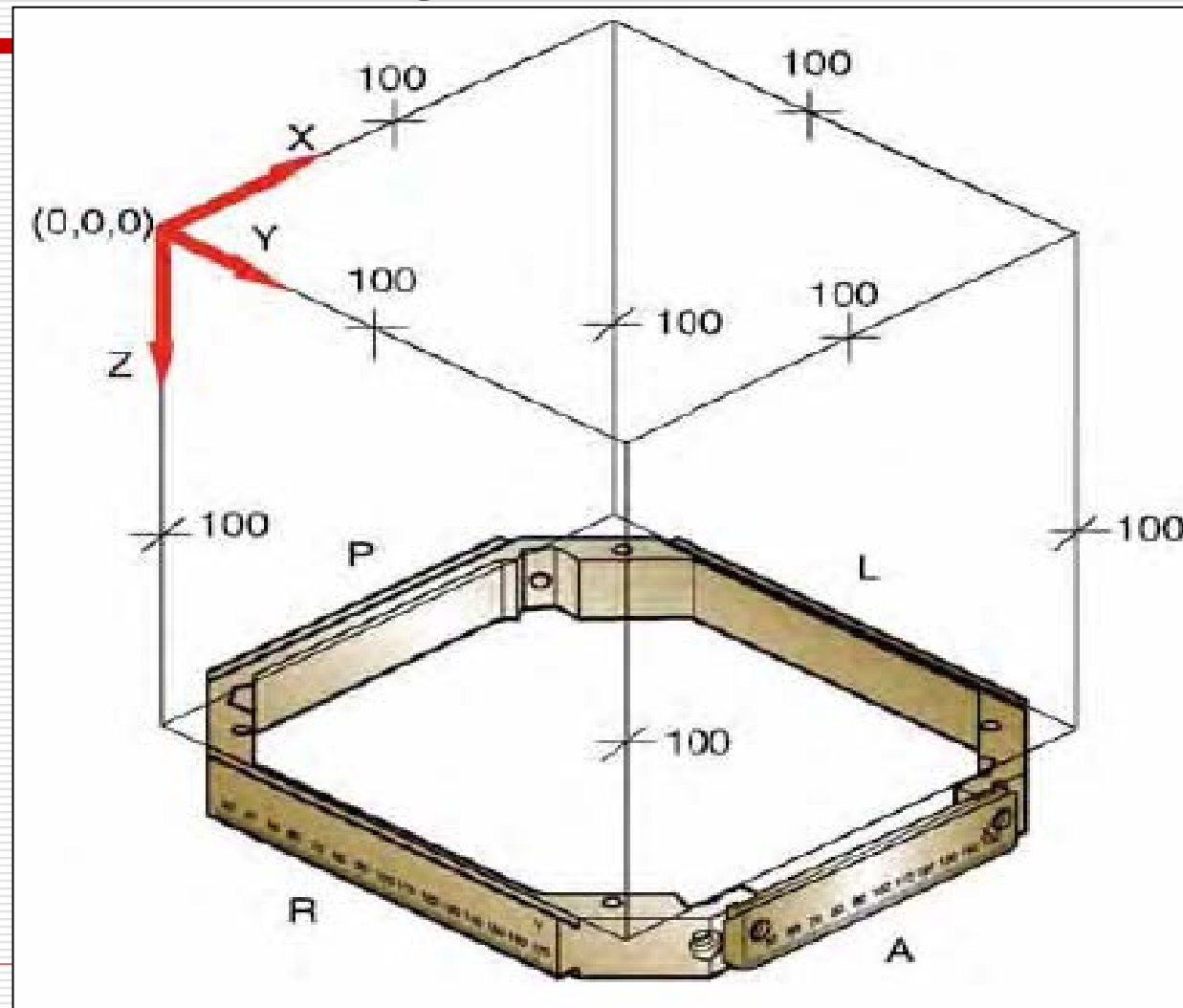

# Leksell stereotactic system



# Fusion MRI-CT

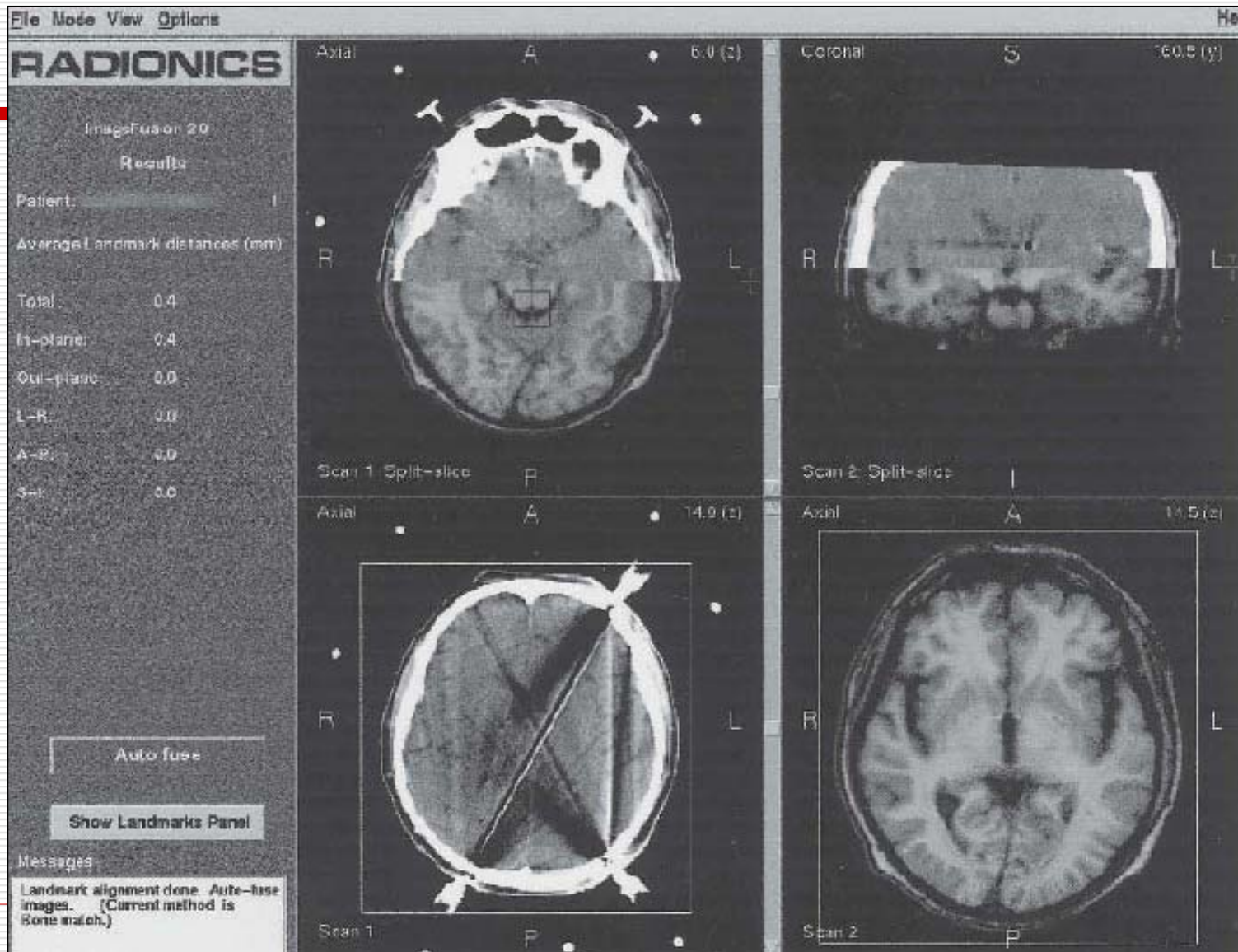

# BrainLab Image Guided System

---



# MER Diagram

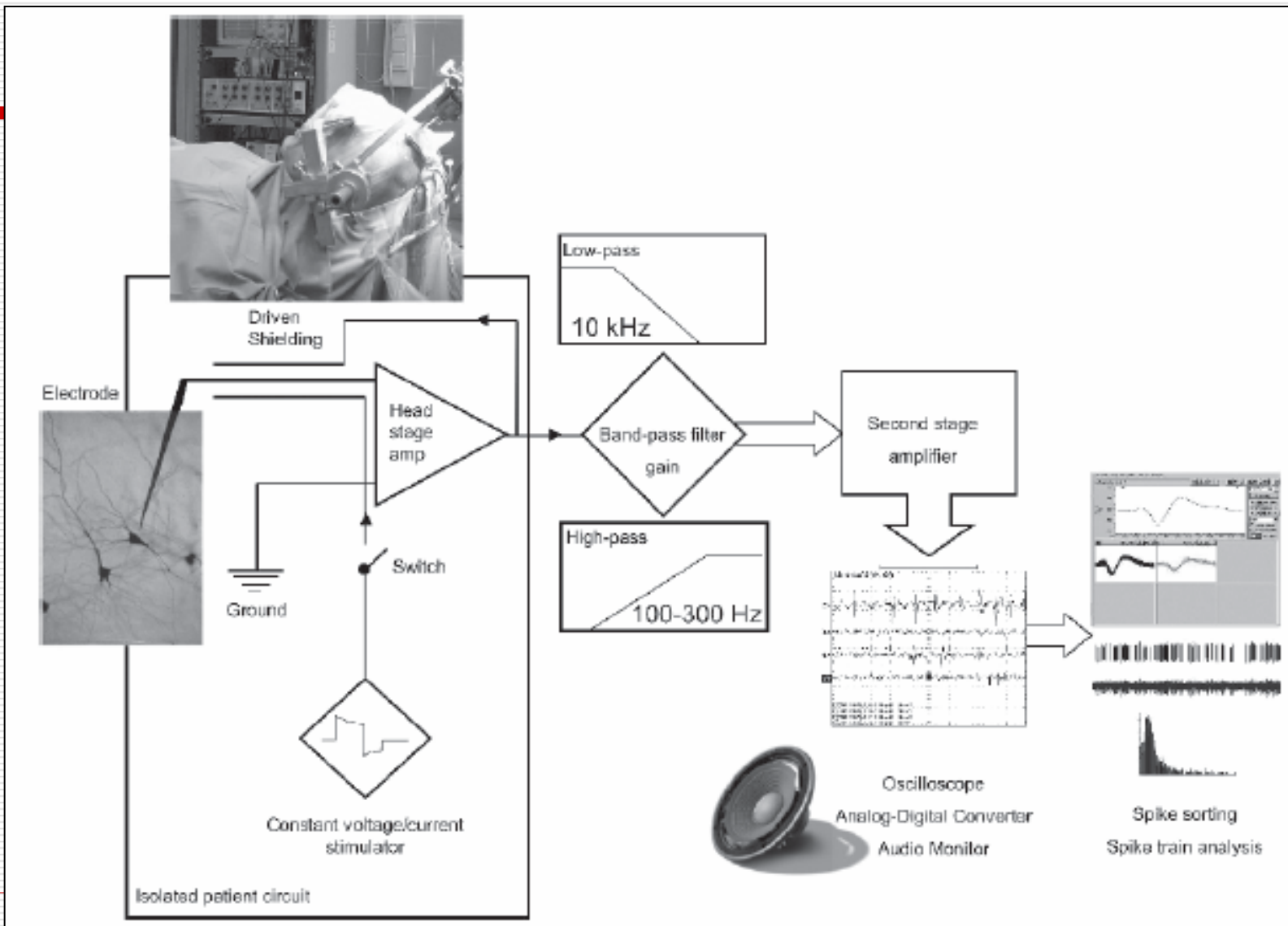

# Posicion intra Qx

---



# GPI MER

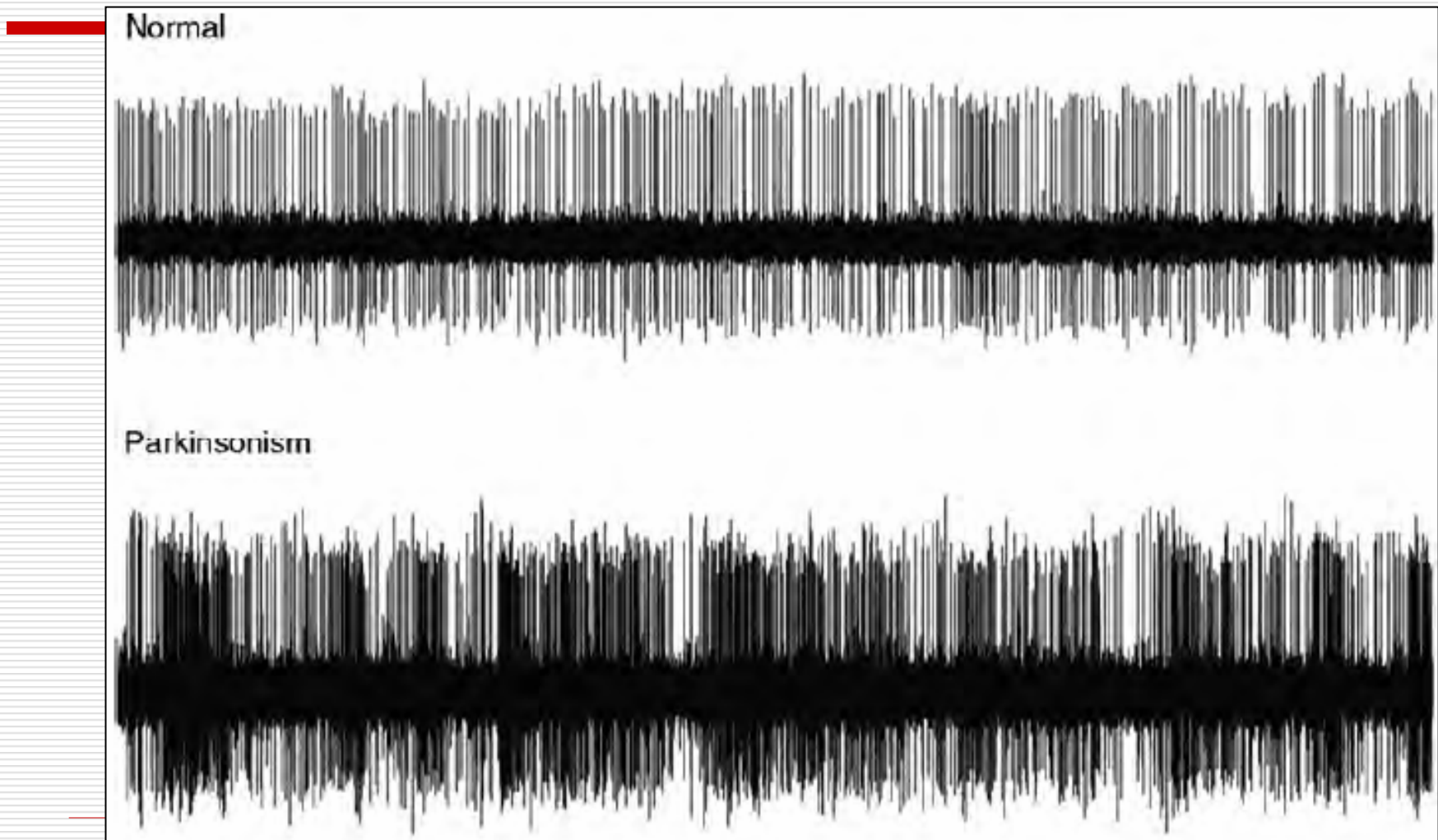

# DBS volumen de influencia

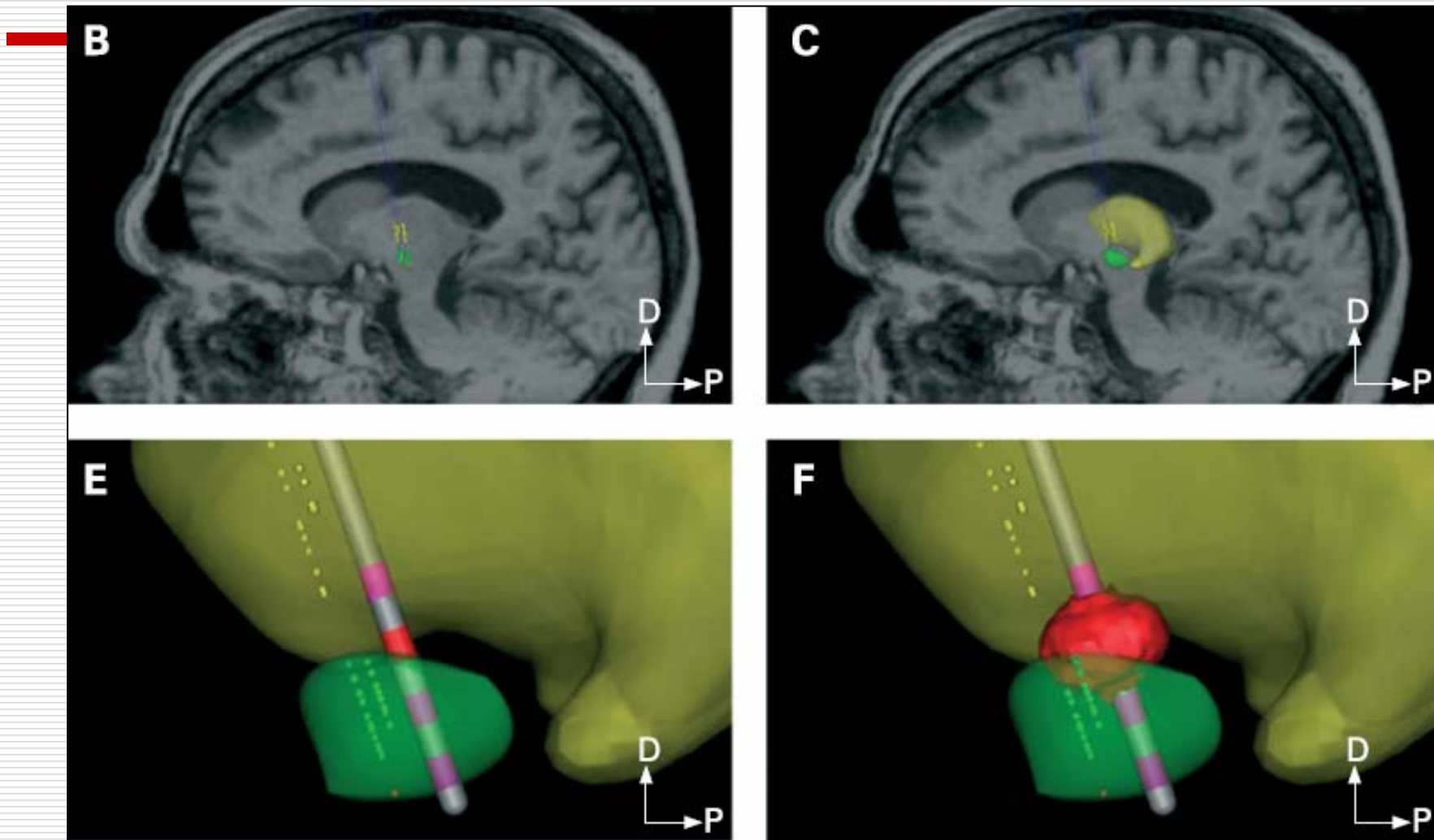

# Eleccion de contacto

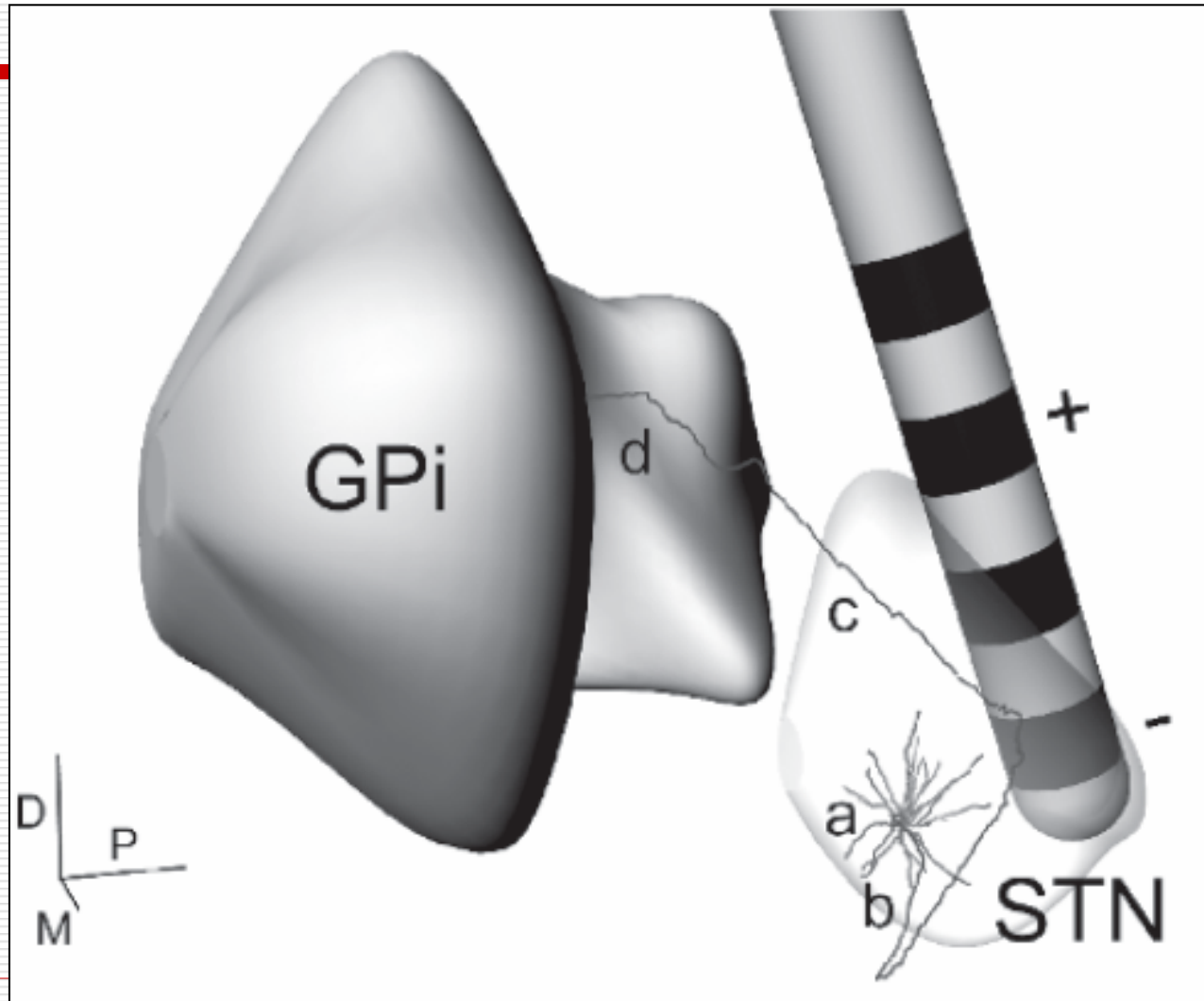

# GPI Programming

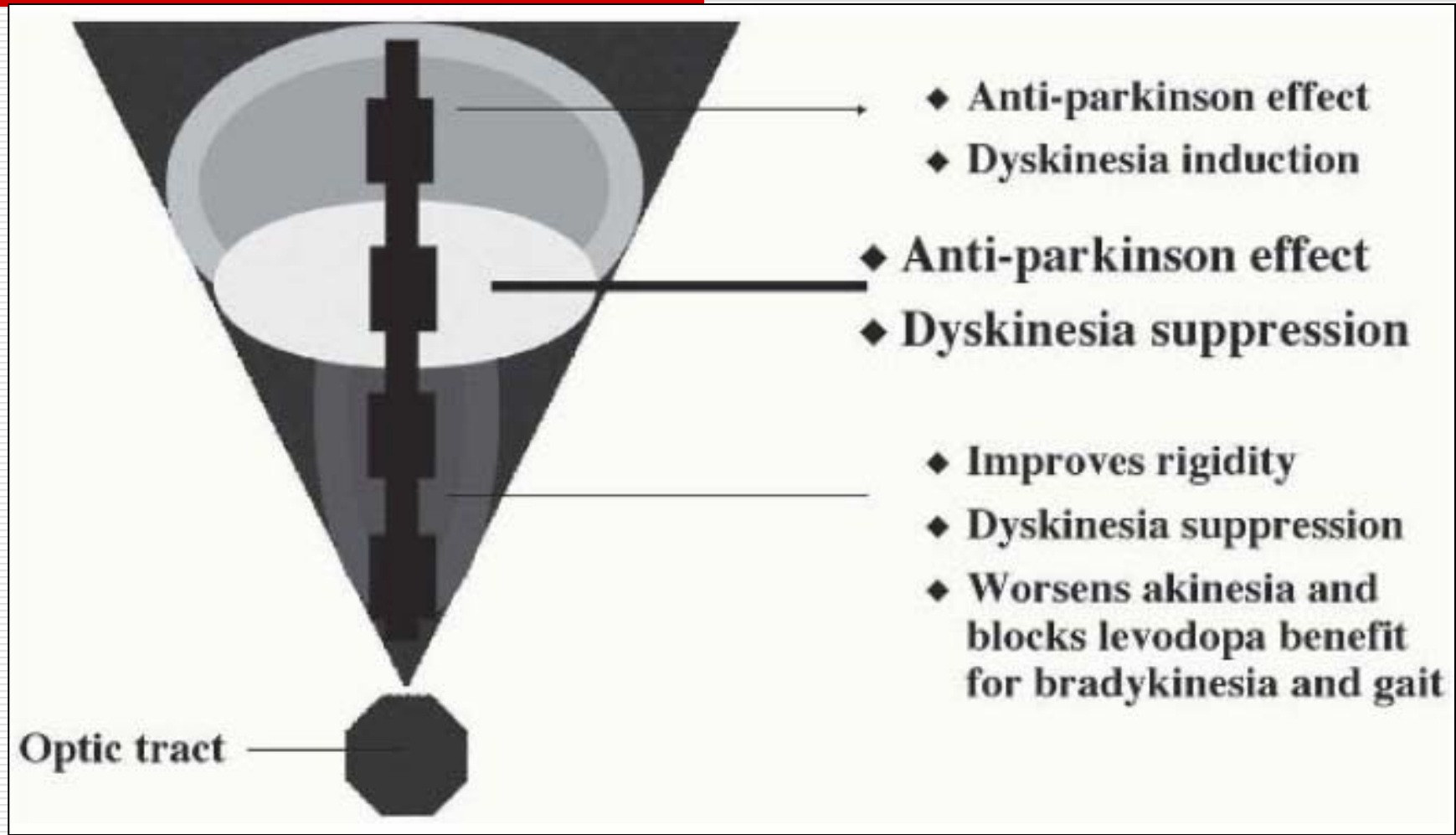

# Terapia del Dolor en Distrotonia

---

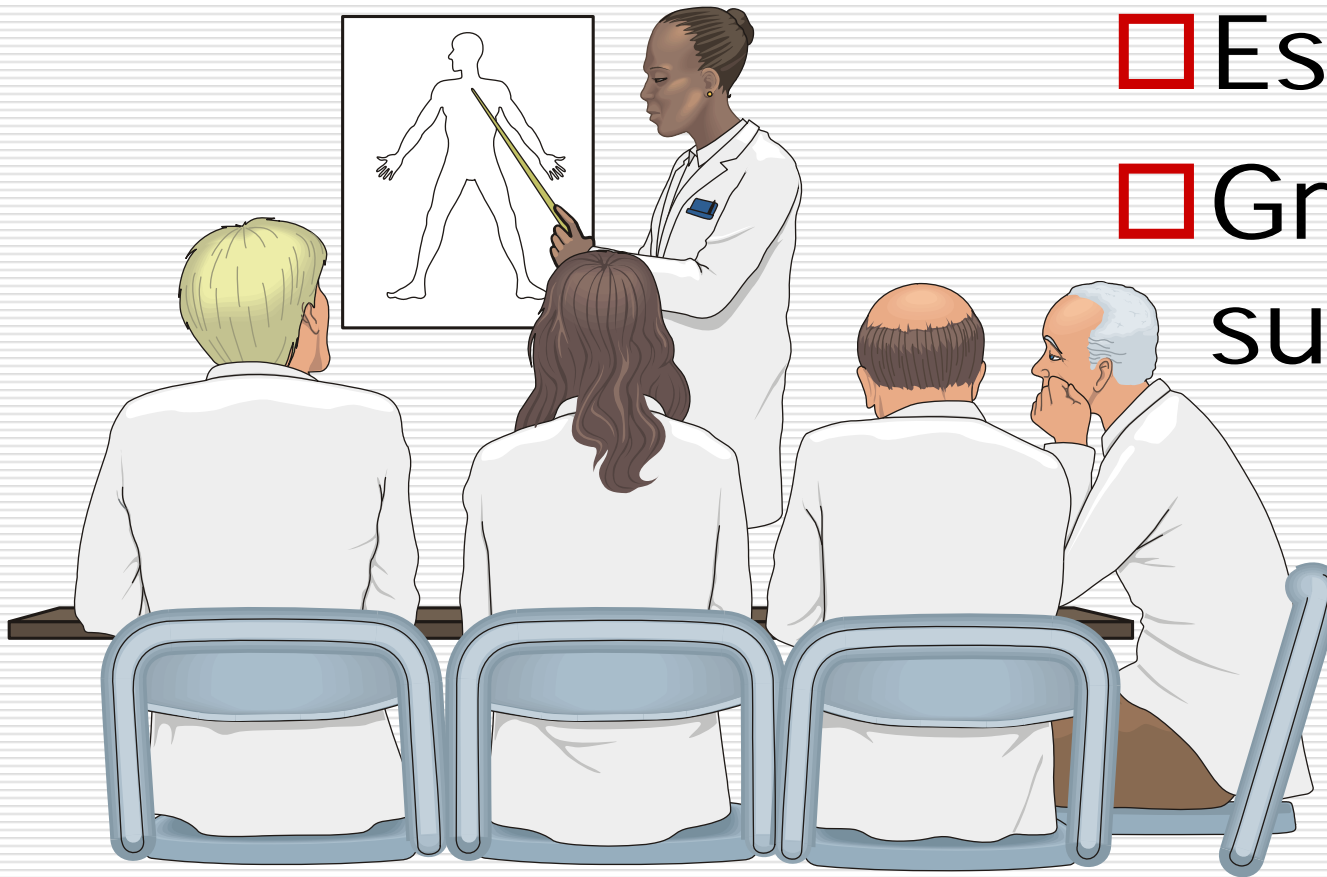

- Es todo
- Gracias por su atención

